

RONDO ACCESSORIES

SUMMARY

Rondo has a range of accessories to complement our steel wall and ceiling systems, which includes Top Hats, Reveal Beads and Angles, as well as a rod bending tool for suspended ceiling applications.

SUITABLE FOR:

Top Hats:

- internal and external applications
- higher wind loading areas or with heavy duty sheeting
- vertical fascias and soffits

Heavy Duty Steel Angles:

- Autoclaved Aerated Concrete Panel Systems (AAC) and steel framing requirements for façade systems.

Reveal Beads:

- window openings

Speedpanel Channel & Angle:

- 78mm Speedpanel systems

Rod Bender:

- Rondo 121 Plain Rod and 122 Threaded One End Rod

SPECIAL FEATURES

- Wide variety of Top Hat profiles to suit most external and internal applications and can be installed either vertically or horizontally
- Top Hats and Heavy Duty Angles are manufactured from G200 Z275 Galvanised Steel
- Heavy Duty Angles are available in 0.75 & 1.15bmt steel thicknesses
- Reveal Beads are cold rolled from 0.9mm Zincanneal steel for strength
- Reveal Beads are UV-resistant to withstand harsh UV rays without cracking or breaking down
- Speedpanel Channel and Angles are made from G2 Z275 Galvabond Steel and available in 1.15bmt (1.2mm TCT) steel thickness
- Rondo Rod Bender can bend up to 3 rods at one time to the required 30° angle for suspended ceiling applications

IN PRACTICE

Many components in the Rondo accessory range have been used in leading projects to complement other Rondo wall and ceiling systems, including the use of Top Hats in the new *Queensland Children's Hospital* project.

IMPORTANT NOTE:

Rondo recommends its products and systems are installed by a qualified tradesperson and according to the relevant codes and standards outlined on page 256 of this manual.

CONTENTS:

ACCESSORIES	224
TOP HATS	
• INSTALLATION	225
• FASTENERS	227
• SECTION DIMENSIONS	229
• SERVICEABILITY LIMIT STATE LOAD TABLES	230
• ULTIMATE LIMIT STATE LOAD TABLES	240
REVEAL BEADS	250
ANGLES	251
SPEEDPANEL	252
ROD BENDER	253

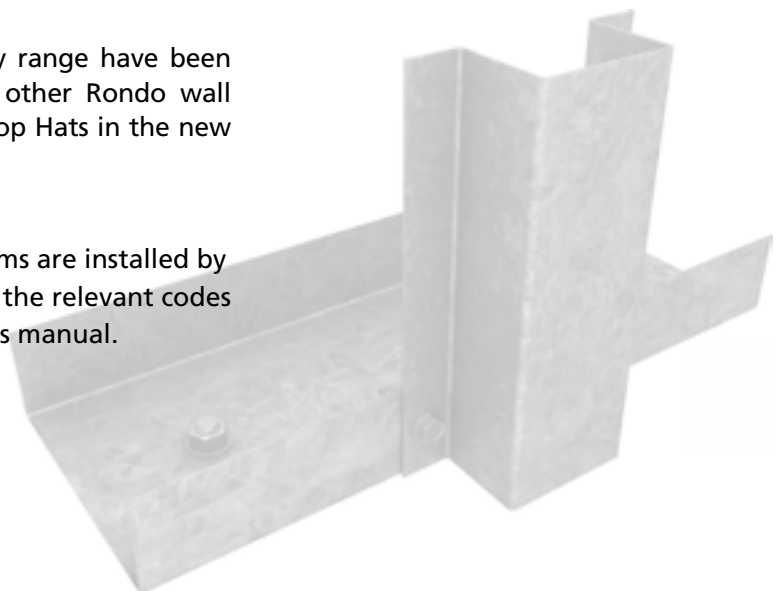

ACCESSORIES

MEDIUM WEIGHT TOP HATS

M515	15 x 15 x 50 x 15 x 15 x 0.75bmt
M525	20 x 25 x 50 x 25 x 20 x 0.75bmt
M535	20 x 35 x 50 x 35 x 20 x 0.75bmt
M545	20 x 45 x 50 x 45 x 20 x 0.75bmt
M550	20 x 50 x 50 x 50 x 20 x 0.75bmt
M560	20 x 60 x 50 x 60 x 20 x 0.75bmt
M715	15 x 15 x 75 x 15 x 15 x 0.75bmt
M725	20 x 25 x 75 x 25 x 20 x 0.75bmt
M735	20 x 35 x 75 x 35 x 20 x 0.75bmt
M750	20 x 50 x 75 x 50 x 20 x 0.75bmt

HEAVY WEIGHT TOP HATS

H515	15 x 15 x 50 x 15 x 15 x 1.15bmt
H525	20 x 25 x 50 x 25 x 20 x 1.15bmt
H535	20 x 35 x 50 x 35 x 20 x 1.15bmt
H545	20 x 45 x 50 x 45 x 20 x 1.15bmt
H550	20 x 50 x 50 x 50 x 20 x 1.15bmt
H560	20 x 60 x 50 x 60 x 20 x 1.15bmt
H715	15 x 15 x 75 x 15 x 15 x 1.15bmt
H725	20 x 25 x 75 x 25 x 20 x 1.15bmt
H735	20 x 35 x 75 x 35 x 20 x 1.15bmt
H750	20 x 50 x 75 x 50 x 20 x 1.15bmt

TOP HAT CLEATS

550	50 x 55 x 1.9bmt Cleat
535	50 x 35 x 1.9bmt Cleat
750	75 x 55 x 1.9bmt Cleat
735	75 x 35 x 1.9bmt Cleat

REVEAL BEADS

REVB020	20mm Reveal Bead
REVB025	25mm Reveal Bead
REVB035	35mm Reveal Bead
REVB050	50mm Reveal Bead
REVB060	60mm Reveal Bead
REVB065	65mm Reveal Bead
REVB075	75mm Reveal Bead
REVB080	80mm Reveal Bead
REVB090	90mm Reveal Bead
REVB100	100mm Reveal Bead
REVB110	110mm Reveal Bead
REVB120	120mm Reveal Bead
REVB150	150mm Reveal Bead

ANGLES

552	25 x 25 x 0.70bmt Angle
553	35 x 35 x 0.70bmt Angle
554	50 x 50 x 0.70bmt Angle
HB50	50 x 50 x 0.80 Slotted Angle
HB75	75 x 50 x 1.15 Slotted H/D Angle
555	75 x 75 x 0.75 H/D Angle
556	75 x 75 x 1.15bmt H/D Angle
557	100 x 100 x 0.75bmt H/D Angle
558	100 x 100 x 1.15bmt H/D Angle

SPEEDPANEL

559	50 x 50 x 1.15bmt Speedpanel 'C' Angle
820	82 x 51 x 1.15bmt Speedpanel 'C' Channel

ROD BENDER

130	Rod Bender
-----	------------

TOP HATS



MEDIUM/HEAVY

TOP HAT CLEATS



550

535

750

735

REVEAL BEADS



REVB

ANGLES



552/553/554

HB50/HB75

555/556

557/558

SPEEDPANEL

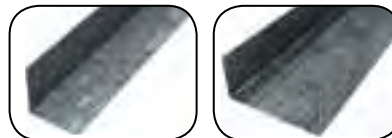

559

820

ROD BENDER



130

TOP HATS

Installation

Rondo produces a wide range of standard “off the shelf” Top Hat profiles for a variety of uses both internally and externally, including applications where there is a higher wind loading or where heavy duty sheeting is to be installed. Rondo also produces a range of complementary adjustable fixing cleats.

The Rondo Fixing Cleats enable adjustable fixing of Top Hats to steel or masonry/concrete substrates as well to steel stud framing, providing adjustment for plumb and level of the cleat to the structure and of the Top Hat onto the cleat as shown in Figures 1, 2 and 3.

The cleats are available to suit both 50 and 75mm width Top Hats and in two depths of 35 and 55mm.

These products are available in 0.75bmt (Medium) and 1.15bmt (Heavy) gauges in two different face widths, 50 and 75mm and four different depths, 15, 25, 35 and 50mm. Rondo Top Hats are manufactured from G200 Z275 Gal steel.

The product codes and details are referenced in the accompanying Ultimate and Serviceability Limit State Load Tables.

INSTALLATION TO CONCRETE OR STEELWORK

Top Hats can be fixed vertically or horizontally to suit the installer’s requirements, either screw fixed directly to a supporting substrate or fixed with the Rondo cleats (see Figures 1 & 2).

1



■ TOP HAT FIXED TO STEELWORK
FIXINGS: CLEAT TO STEELWORK AND TOP HAT TO CLEAT WITH #12 TEK SCREWS AS SHOWN

2



■ TOP HAT FIXED TO CONCRETE
ANCHOR SIZE TO CONCRETE/MASONRY 8-10mm AS SPECIFIED. TOP HAT TO CLEAT WITH #12 TEK SCREWS AS SHOWN

TOP HATS

Installation (continued)

INSTALLATION TO STEEL STUD FRAMING

Particularly with regards to External Stud Framing, Rondo Top Hats can be fixed either vertically with the adjustable cleats or direct fixed horizontally with packers if necessary.

If fixing vertically, the cleat method must be used as shown in Figure 3.

When fixing vertically, follow the top fixing and bottom fixing requirements shown in Figures 4 & 5.

At all times refer to the Serviceability Limit State Load Tables for the appropriate fixing dimensions on page 230 and ensure the Project Engineer has signed off on your proposal.

FIGURE 3

Screw fixing Cleat to Stud to be specified by Rondo as it depends on capacity required.
Top Hat to Cleat fixing with 2 x #12 Tek Screws as shown.

FIGURE 4

Top Hat to Slotted Deflection Head Track with 2 x #10 Tek Screws fixed at a maximum of 15mm from bottom of slot.

FIGURE 5

Top Hat to Base Track to be fixed with 2 x #10 Tek Screws at mid point of Track flange.

3



■ VERTICAL FIXING METHOD USING CLEAT

4



■ TOP FIXING

5



■ BOTTOM FIXING

Top Hat Fasteners

The preceding figures 1–3 illustrate the fixing of Top Hats to steelwork, masonry/concrete and to steel stud framing, detailing the appropriate Hex Head Tek screws to use.

Table 1 provides information on the capacities for #12 Hex Head Tek Screws when used in conjunction with the structural fixings methods suggested and set out as shown in Figure 6, either direct fixed through the Top Hat flanges as Figure 7 or when installing the Rondo Top Hat Cleats as in Figure 8.

In the case of fixing to masonry/concrete the relevant masonry anchor chosen should have, at the least, a capacity the same as that for the Tek screws shown in Table 1.

NOTE: When using Rondo Top Hats to install fibre cement sheeting with an express joint detail it is important to ensure the board manufacturers recommendations on edge distance for securing the board is considered when choosing the appropriate face width Top Hat profile. Similarly, building board manufacturers recommendations in respect to the installation of Control Joints should be followed closely to ensure proper function and performance of the system.

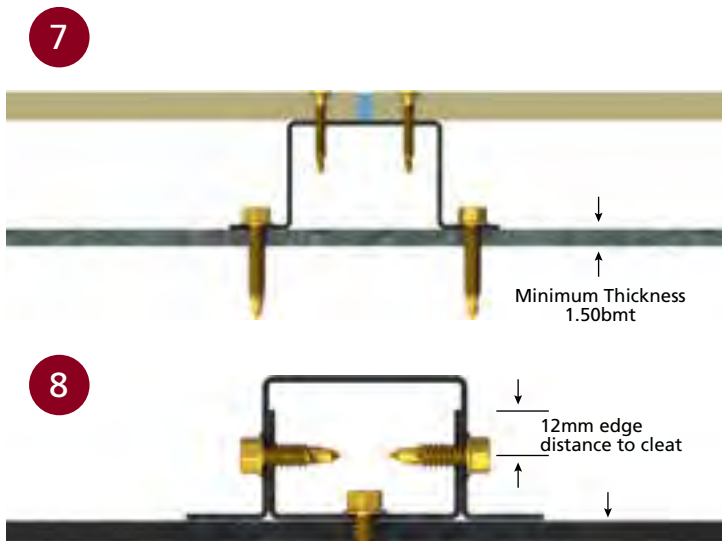
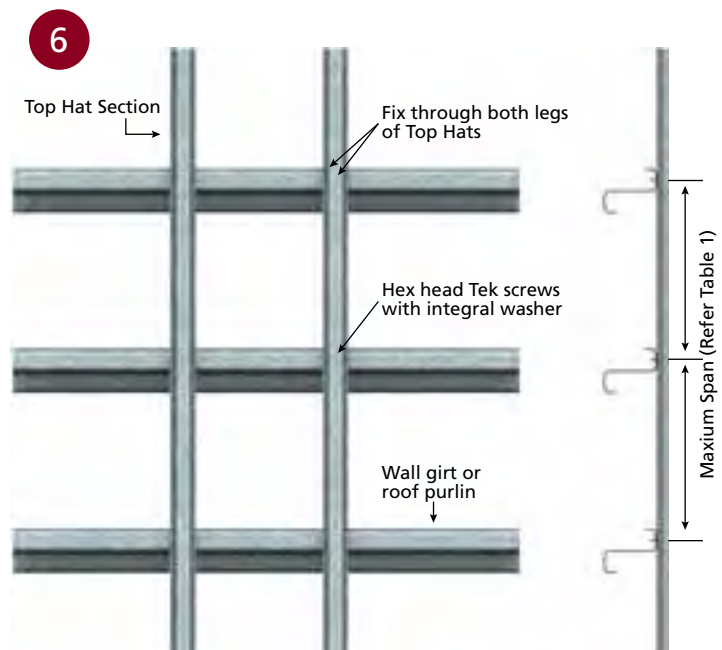

Note: When substrate is concrete, then anchor bolt capacity equal to the capacity shown in Table 1.

TABLE 1: #12 HEX HEAD FASTENERS

TOP HAT SPAN	TOP HAT SPACING	NUMBER OF FASTENERS	ULTIMATE WIND LOAD (kPa)
900	450	2	6.40
	600	2	4.80
1200	450	2	4.80
	600	2	3.60
1500	450	2	3.85
	600	2	2.90
1800	450	2	3.20
	600	2	2.40

NOTES:

1. Minimum thickness of supporting structure to be 1.50 bmt, G450 material - ie: purlin type support
2. Fastener head/washer diameter to be 12.5mm minimum
3. All screws to be manufactured in accordance with AS 3566. Screw coating to be selected based on installation requirements and manufacturers.

TOP HATS

Installation (continued)

INSTALLATION TO STEEL STUD FRAMING USING RONDO NOGGING TRACK

Some façade systems require the installation of Top Hats vertically and there will be occasions where studs do not coincide with the Top Hat spacing requirement. That being the case, it may be necessary to install Top Hats onto the steel Nogging Track.

There are strict limitations of fixing to Nogging Track and therefore, any such situation that requires this method needs to be referred to your Rondo Representative who will first seek written approval from Rondo's Technical Services Department.

If approved by Rondo's Technical Services Department, it will be necessary to ensure the junction between the stud and the Nogging track is strengthened by the use of Rondo 545 brackets (Figure 9) and installed as shown in Figures 10 and 11.

It is important that these details are followed as failure to follow this procedure may jeopardise onsite safety and system performance, and as such, invalidate the Rondo warranty.



■ 545 BRACKET

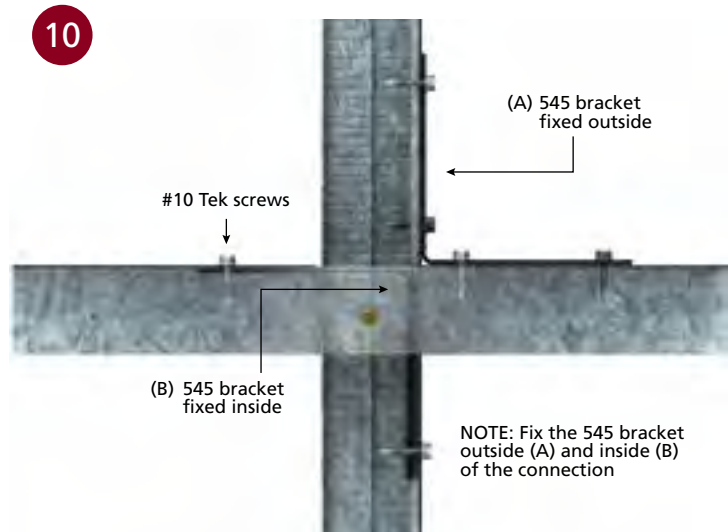

■ 545 BRACKET INSTALLATION

Section Dimensions

MATERIAL SPECIFICATIONS

The sections are cold roll formed from zinc coated steel strip, which is manufactured to AS1397.

Steel Grade: G2

Yield Strength: $F_y = 270$ MPa (typical)

Coating Grade: Z275 – 275g/m² zinc

Base Metal Thickness: As specified

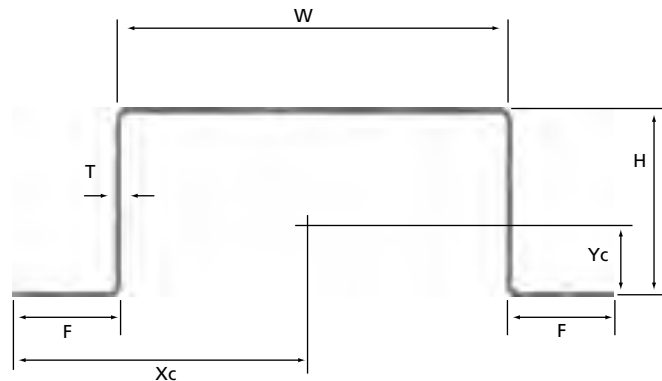

TABLE 2

RONDO PART NO	AREA (mm ²)	T (BMT) (mm)	W (mm)	H (mm)	F (mm)	Xc (mm)	Yc (mm)	YIELD STRESS (MPa)	SELF-WEIGHT (kg/m)
M515	79.45	0.75	50.0	15.0	15.0	40.1	6.27	270	0.61
M525	97.45	0.75	50.0	25.0	20.0	42.1	11.17	270	0.75
M535	111.7	0.75	50.0	35.0	20.0	41.6	15.74	270	0.89
M545	127.1	0.75	50.0	45.0	18.4	42.6	20.61	270	1.05
M550	134.2	0.75	50.0	50.0	20.0	41.6	22.89	270	1.08
M560	150.0	0.75	50.0	60.0	18.4	42.6	27.90	270	1.24
M715	97.45	0.75	75.0	15.0	15.0	52.1	5.07	270	0.78
M725	115.4	0.75	75.0	25.0	20.0	54.1	9.33	270	0.95
M735	131.2	0.75	75.0	35.0	20.0	54.6	13.65	270	1.06
M750	153.7	0.75	75.0	50.0	20.0	54.6	20.28	270	1.26
H515	117.2	1.15	50.0	15.0	15.0	38.67	6.12	270	0.91
H525	147.1	1.15	50.0	25.0	20.0	41.67	11.16	270	1.19
H535	169.4	1.15	50.0	35.0	20.0	41.37	15.78	270	1.37
H545	192.0	1.15	50.0	45.0	18.2	42.0	20.54	270	1.56
H550	204.6	1.15	50.0	50.0	20.0	41.67	23.03	270	1.66
H560	226.2	1.15	50.0	60.0	18.2	42.0	27.80	270	1.84
H715	147.1	1.15	75.0	15.0	15.0	51.67	5.10	270	1.16
H725	175.9	1.15	75.0	25.0	20.0	54.17	9.43	270	1.43
H735	198.9	1.15	75.0	35.0	20.0	54.17	13.65	270	1.61
H750	235.7	1.15	75.0	50.0	20.0	55.17	20.55	270	1.89

TOP HATS

Serviceability Limit State Load Tables (kPa)

0.75bmt (M) Top Hats

TABLE 3: PART NO. M515: 15 x 15 x 50 x 15 x 15mm

SPAN	M515 TOP HAT SPACING							
	L / 250				L / 360			
	SINGLE SPAN		CONTINUOUS SPAN		SINGLE SPAN		CONTINUOUS SPAN	
	450	600	450	600	450	600	450	600
900	0.58	0.43	1.10	0.82	0.39	0.29	0.76	0.57
1000	0.41	0.31	0.80	0.59	0.28	NA	0.55	0.41
1100	0.31	NA	0.60	0.44	NA	NA	0.41	0.30
1200	NA	NA	0.45	0.34	NA	NA	0.31	NA
1300	NA	NA	0.35	0.26	NA	NA	NA	NA
1400	NA	NA	0.28	NA	NA	NA	NA	NA
1500	NA	NA	NA	NA	NA	NA	NA	NA
1600	NA	NA	NA	NA	NA	NA	NA	NA
1700	NA	NA	NA	NA	NA	NA	NA	NA
1800	NA	NA	NA	NA	NA	NA	NA	NA

TABLE 4: PART NO. M525: 20 x 25 x 50 x 25 x 20mm

SPAN	M525 TOP HAT SPACING							
	L / 250				L / 360			
	SINGLE SPAN		CONTINUOUS SPAN		SINGLE SPAN		CONTINUOUS SPAN	
	450	600	450	600	450	600	450	600
900	1.96	1.46	3.72	2.78	1.35	1.01	2.57	1.93
1000	1.42	1.06	2.70	2.02	0.98	0.73	1.87	1.40
1100	1.06	0.79	2.03	1.51	0.73	0.54	1.40	1.05
1200	0.82	0.61	1.56	1.16	0.56	0.41	1.07	0.80
1300	0.64	0.47	1.22	0.91	0.44	0.32	0.84	0.63
1400	0.51	0.37	0.97	0.72	0.35	0.25	0.67	0.50
1500	0.41	0.30	0.79	0.59	0.28	NA	0.54	0.40
1600	0.33	NA	0.64	0.48	NA	NA	0.44	0.33
1700	0.27	NA	0.53	0.40	NA	NA	0.36	0.27
1800	NA	NA	0.45	0.33	NA	NA	0.30	NA

NOTES:

1. NA means the maximum kPa value is less than 0.25 kPa and the top hat configuration is not appropriate
2. Serviceability limit state load capacity to be calculated in accordance with AS/NZS 1170.0 or AS/NZS 1170.2 as applicable
3. Connections to be independently checked
4. Ultimate limit state to be checked separately
5. Lining contribution not included
6. Cantilever not to exceed 0.2 times the backspan

TABLE 5: PART NO. M535: 20 x 35 x 50 x 35 x 20mm

SPAN	M535 TOP HAT SPACING							
	L / 250				L / 360			
	SINGLE SPAN		CONTINUOUS SPAN		SINGLE SPAN		CONTINUOUS SPAN	
	450	600	450	600	450	600	450	600
900	4.17	3.12	7.88	5.90	2.89	2.16	5.47	4.09
1000	3.03	2.27	5.74	4.30	2.10	1.57	3.98	2.98
1100	2.27	1.70	4.31	3.22	1.57	1.17	2.98	2.23
1200	1.75	1.30	3.31	2.48	1.21	0.90	2.29	1.72
1300	1.37	1.02	2.60	1.95	0.94	0.70	1.80	1.35
1400	1.09	0.81	2.08	1.55	0.75	0.56	1.44	1.07
1500	0.88	0.66	1.69	1.26	0.61	0.45	1.16	0.87
1600	0.73	0.54	1.39	1.03	0.50	0.37	0.96	0.71
1700	0.60	0.45	1.15	0.86	0.41	0.30	0.79	0.59
1800	0.50	0.37	0.97	0.72	0.34	0.25	0.67	0.49

TABLE 6: PART NO. M545: 20 x 45 x 50 x 45 x 20mm

SPAN	M545 TOP HAT SPACING							
	L / 250				L / 360			
	SINGLE SPAN		CONTINUOUS SPAN		SINGLE SPAN		CONTINUOUS SPAN	
	450	600	450	600	450	600	450	600
900	6.07	4.55	7.15	5.36	5.12	3.84	7.15	5.36
1000	4.61	3.45	5.79	4.34	3.72	2.79	5.79	4.34
1100	3.53	2.64	4.79	3.59	2.79	2.09	4.79	3.59
1200	2.71	2.03	4.03	3.02	2.14	1.61	4.03	3.02
1300	2.08	1.56	3.42	2.56	1.68	1.26	3.24	2.43
1400	1.60	1.20	2.91	2.18	1.34	1.00	2.59	1.94
1500	1.26	0.94	2.49	1.87	1.08	0.81	2.10	1.57
1600	1.00	0.75	2.16	1.62	0.89	0.67	1.73	1.29
1700	0.81	0.61	1.88	1.41	0.74	0.55	1.43	1.07
1800	0.66	0.50	1.63	1.22	0.62	0.46	1.20	0.90

NOTES:

1. NA means the maximum kPa value is less than 0.25 kPa and the Top Hat configuration is not appropriate
2. Serviceability limit state load capacity to be calculated in accordance with AS/NZS 1170.0 or AS/NZS 1170.2 as applicable
3. Connections to be independently checked
4. Ultimate limit state to be checked separately
5. Lining contribution not included
6. Cantilever not to exceed 0.2 times the backspan

TOP HATS

Serviceability Limit State Load Tables (kPa)

0.75bmt (M) Top Hats (continued)

TABLE 7: PART NO. M550: 20 x 50 x 50 x 50 x 20mm

SPAN	M550 TOP HAT SPACING							
	L / 250				L / 360			
	SINGLE SPAN		CONTINUOUS SPAN		SINGLE SPAN		CONTINUOUS SPAN	
	450	600	450	600	450	600	450	600
900	9.51	7.13	17.97	13.47	6.60	4.94	12.47	9.35
1000	6.93	5.19	13.09	9.81	4.81	3.60	9.09	6.81
1100	5.20	3.90	9.83	7.37	3.61	2.70	6.82	5.11
1200	4.00	3.00	7.57	5.67	2.77	2.07	5.25	3.93
1300	3.14	2.35	5.95	4.46	2.18	1.63	4.12	3.09
1400	2.51	1.88	4.76	3.56	1.74	1.30	3.30	2.47
1500	2.04	1.52	3.86	2.89	1.41	1.05	2.68	2.00
1600	1.68	1.25	3.18	2.38	1.16	0.86	2.20	1.65
1700	1.39	1.04	2.65	1.98	0.96	0.72	1.83	1.37
1800	1.17	0.87	2.23	1.67	0.81	0.60	1.54	1.15

TABLE 8: PART NO. M560: 20 x 60 x 50 x 60 x 20mm

SPAN	M560 TOP HAT SPACING							
	L / 250				L / 360			
	SINGLE SPAN		CONTINUOUS SPAN		SINGLE SPAN		CONTINUOUS SPAN	
	450	600	450	600	450	600	450	600
900	9.60	7.20	10.98	8.24	9.60	7.20	10.98	8.24
1000	7.33	5.50	8.90	6.67	7.33	5.50	8.90	6.67
1100	5.66	4.24	7.36	5.52	5.63	4.22	7.36	5.52
1200	4.38	3.29	6.19	4.64	4.33	3.25	6.19	4.64
1300	3.39	2.54	5.27	3.95	3.39	2.54	5.27	3.95
1400	2.62	1.96	4.53	3.40	2.62	1.96	4.53	3.40
1500	2.04	1.53	3.90	2.92	2.04	1.53	3.90	2.92
1600	1.61	1.21	3.37	2.53	1.61	1.21	3.37	2.53
1700	1.30	0.97	2.94	2.21	1.30	0.97	2.91	2.18
1800	1.05	0.79	2.54	1.90	1.05	0.79	2.44	1.83

NOTES:

1. NA means the maximum kPa value is less than 0.25 kPa and the top hat configuration is not appropriate
2. Serviceability limit state load capacity to be calculated in accordance with AS/NZS 1170.0 or AS/NZS 1170.2 as applicable
3. Connections to be independently checked
4. Ultimate limit state to be checked separately
5. Lining contribution not included
6. Cantilever not to exceed 0.2 times the backspan

TABLE 9: PART NO. M715: 15 x 15 x 75 x 15 x 15mm

SPAN	M715 TOP HAT SPACING							
	L / 250				L / 360			
	SINGLE SPAN		CONTINUOUS SPAN		SINGLE SPAN		CONTINUOUS SPAN	
	450	600	450	600	450	600	450	600
900	0.66	0.49	1.27	0.94	0.45	0.34	0.87	0.65
1000	0.48	0.35	0.92	0.68	0.33	NA	0.63	0.47
1100	0.35	0.26	0.68	0.51	NA	NA	0.47	0.35
1200	0.27	NA	0.52	0.39	NA	NA	0.36	0.26
1300	NA	NA	0.41	0.30	NA	NA	0.28	NA
1400	NA	NA	0.32	NA	NA	NA	NA	NA
1500	NA	NA	0.26	NA	NA	NA	NA	NA
1600	NA	NA	NA	NA	NA	NA	NA	NA
1700	NA	NA	NA	NA	NA	NA	NA	NA
1800	NA	NA	NA	NA	NA	NA	NA	NA

TABLE 10: PART NO. M725: 20 x 25 x 75 x 25 x 20mm

SPAN	M725 TOP HAT SPACING							
	L / 250				L / 360			
	SINGLE SPAN		CONTINUOUS SPAN		SINGLE SPAN		CONTINUOUS SPAN	
	450	600	450	600	450	600	450	600
900	2.27	1.70	4.30	3.22	1.57	1.17	2.98	2.23
1000	1.65	1.23	3.13	2.34	1.14	0.85	2.17	1.62
1100	1.23	0.92	2.35	1.76	0.85	0.63	1.62	1.21
1200	0.95	0.70	1.80	1.35	0.65	0.48	1.25	0.93
1300	0.74	0.55	1.41	1.06	0.51	0.38	0.98	0.73
1400	0.59	0.44	1.13	0.84	0.40	0.30	0.78	0.58
1500	0.47	0.35	0.91	0.68	0.32	NA	0.63	0.47
1600	0.39	0.29	0.75	0.56	0.26	NA	0.51	0.38
1700	0.32	NA	0.62	0.46	NA	NA	0.43	0.31
1800	0.27	NA	0.52	0.39	NA	NA	0.36	0.26

NOTES:

1. NA means the maximum kPa value is less than 0.25 kPa and the Top Hat configuration is not appropriate
2. Serviceability limit state load capacity to be calculated in accordance with AS/NZS 1170.0 or AS/NZS 1170.2 as applicable
3. Connections to be independently checked
4. Ultimate limit state to be checked separately
5. Lining contribution not included
6. Cantilever not to exceed 0.2 times the backspan

TOP HATS

Serviceability Limit State Load Tables (kPa)

0.75bmt (M) Top Hats (continued)

TABLE 11: PART NO. M735: 20 x 35 x 75 x 35 x 20mm

SPAN	M735 TOP HAT SPACING							
	L / 250				L / 360			
	SINGLE SPAN		CONTINUOUS SPAN		SINGLE SPAN		CONTINUOUS SPAN	
	450	600	450	600	450	600	450	600
900	4.94	3.70	9.34	7.00	3.42	2.56	6.48	4.85
1000	3.59	2.69	6.80	5.09	2.49	1.86	4.72	3.53
1100	2.70	2.02	5.10	3.82	1.87	1.39	3.54	2.65
1200	2.07	1.55	3.93	2.94	1.43	1.07	2.72	2.04
1300	1.62	1.21	3.08	2.31	1.12	0.84	2.14	1.60
1400	1.30	0.97	2.47	1.84	0.89	0.67	1.71	1.27
1500	1.05	0.78	2.00	1.50	0.72	0.54	1.38	1.03
1600	0.86	0.64	1.65	1.23	0.59	0.44	1.14	0.85
1700	0.72	0.53	1.37	1.02	0.49	0.36	0.94	0.70
1800	0.60	0.44	1.15	0.86	0.41	0.30	0.79	0.59

TABLE 12: PART NO. M750: 20 x 50 x 75 x 50 x 20mm

SPAN	M750 TOP HAT SPACING							
	L / 250				L / 360			
	SINGLE SPAN		CONTINUOUS SPAN		SINGLE SPAN		CONTINUOUS SPAN	
	450	600	450	600	450	600	450	600
900	11.19	8.39	21.14	15.85	7.77	5.82	14.68	11.00
1000	8.16	6.11	15.41	11.55	5.66	4.24	10.69	8.02
1100	6.12	4.59	11.57	8.67	4.25	3.18	8.03	6.02
1200	4.71	3.53	8.91	6.68	3.27	2.44	6.18	4.63
1300	3.70	2.77	7.00	5.25	2.56	1.92	4.86	3.64
1400	2.96	2.21	5.60	4.20	2.05	1.53	3.88	2.91
1500	2.40	1.80	4.55	3.41	1.66	1.24	3.15	2.36
1600	1.98	1.48	3.75	2.80	1.37	1.02	2.60	1.94
1700	1.64	1.23	3.12	2.34	1.14	0.85	2.16	1.62
1800	1.38	1.03	2.63	1.96	0.95	0.71	1.82	1.36

NOTES:

1. NA means the maximum kPa value is less than 0.25 kPa and the top hat configuration is not appropriate
2. Serviceability limit state load capacity to be calculated in accordance with AS/NZS 1170.0 or AS/NZS 1170.2 as applicable
3. Connections to be independently checked
4. Ultimate limit state to be checked separately
5. Lining contribution not included
6. Cantilever not to exceed 0.2 times the backspan

Serviceability Limit State Load Tables (kPa)

1.15bmt (H) Top Hats

TABLE 13: PART NO. H515: 15 x 15 x 50 x 15 x 15mm

SPAN	H515 TOP HAT SPACING							
	L / 250				L / 360			
	SINGLE SPAN		CONTINUOUS SPAN		SINGLE SPAN		CONTINUOUS SPAN	
	450	600	450	600	450	600	450	600
900	0.80	0.59	1.52	1.14	0.55	0.41	1.05	0.78
1000	0.58	0.43	1.10	0.82	0.39	0.29	0.76	0.57
1100	0.43	0.32	0.82	0.61	0.29	NA	0.57	0.42
1200	0.32	NA	0.63	0.47	NA	NA	0.43	0.32
1300	0.25	NA	0.49	0.36	NA	NA	0.34	NA
1400	NA	NA	0.39	0.29	NA	NA	0.26	NA
1500	NA	NA	0.31	NA	NA	NA	NA	NA
1600	NA	NA	0.25	NA	NA	NA	NA	NA
1700	NA	NA	NA	NA	NA	NA	NA	NA
1800	NA	NA	NA	NA	NA	NA	NA	NA

TABLE 14: PART NO. H525: 20 x 25 x 50 x 25 x 20mm

SPAN	H525 TOP HAT SPACING							
	L / 250				L / 360			
	SINGLE SPAN		CONTINUOUS SPAN		SINGLE SPAN		CONTINUOUS SPAN	
	450	600	450	600	450	600	450	600
900	2.87	2.15	5.43	4.07	1.99	1.49	3.77	2.82
1000	2.09	1.56	3.96	2.96	1.44	1.08	2.74	2.05
1100	1.56	1.17	2.97	2.22	1.08	0.80	2.05	1.54
1200	1.20	0.89	2.28	1.71	0.83	0.61	1.58	1.18
1300	0.94	0.70	1.79	1.34	0.65	0.48	1.24	0.92
1400	0.75	0.56	1.43	1.07	0.51	0.38	0.99	0.73
1500	0.60	0.45	1.16	0.86	0.41	0.31	0.80	0.59
1600	0.49	0.37	0.95	0.71	0.34	NA	0.65	0.49
1700	0.41	0.30	0.79	0.59	0.28	NA	0.54	0.40
1800	0.34	0.25	0.66	0.49	NA	NA	0.45	0.34

NOTES:

1. NA means the maximum kPa value is less than 0.25 kPa and the Top Hat configuration is not appropriate
2. Serviceability limit state load capacity to be calculated in accordance with AS/NZS 1170.0 or AS/NZS 1170.2 as applicable
3. Connections to be independently checked
4. Ultimate limit state to be checked separately
5. Lining contribution not included
6. Cantilever not to exceed 0.2 times the backspan

TOP HATS

Serviceability Limit State Load Tables (kPa)

1.15bmt (H) Top Hats (continued)

TABLE 15: PART NO. H535: 20 x 35 x 50 x 35 x 20mm

SPAN	H535 TOP HAT SPACING							
	L / 250				L / 360			
	SINGLE SPAN		CONTINUOUS SPAN		SINGLE SPAN		CONTINUOUS SPAN	
	450	600	450	600	450	600	450	600
900	6.18	4.63	11.69	8.76	4.29	3.21	8.11	6.08
1000	4.50	3.37	8.51	6.38	3.12	2.34	5.91	4.42
1100	3.38	2.53	6.39	4.79	2.34	1.75	4.43	3.32
1200	2.60	1.94	4.92	3.68	1.80	1.34	3.41	2.55
1300	2.04	1.52	3.86	2.89	1.41	1.05	2.68	2.00
1400	1.63	1.22	3.09	2.31	1.12	0.84	2.14	1.60
1500	1.32	0.98	2.51	1.88	0.91	0.68	1.74	1.30
1600	1.08	0.81	2.06	1.54	0.75	0.56	1.43	1.07
1700	0.90	0.67	1.72	1.28	0.62	0.46	1.19	0.88
1800	0.76	0.56	1.44	1.08	0.52	0.38	1.00	0.74

TABLE 16: PART NO. H545: 20 x 45 x 50 x 45 x 20mm

SPAN	H545 TOP HAT SPACING							
	L / 250				L / 360			
	SINGLE SPAN		CONTINUOUS SPAN		SINGLE SPAN		CONTINUOUS SPAN	
	450	600	450	600	450	600	450	600
900	10.96	8.22	12.61	9.45	7.89	5.92	12.61	9.45
1000	8.28	6.21	10.22	7.66	5.74	4.30	10.22	7.66
1100	6.21	4.66	8.45	6.33	4.30	3.23	8.28	6.21
1200	4.78	3.58	7.10	5.33	3.31	2.48	6.37	4.77
1300	3.75	2.81	6.06	4.54	2.59	1.94	5.00	3.75
1400	2.99	2.24	5.16	3.87	2.07	1.55	3.99	2.99
1500	2.43	1.82	4.44	3.33	1.67	1.25	3.24	2.43
1600	1.99	1.49	3.82	2.86	1.37	1.03	2.66	2.00
1700	1.66	1.24	3.21	2.40	1.14	0.85	2.21	1.66
1800	1.38	1.03	2.69	2.02	0.95	0.71	1.86	1.39

NOTES:

1. NA means the maximum kPa value is less than 0.25 kPa and the top hat configuration is not appropriate
2. Serviceability limit state load capacity to be calculated in accordance with AS/NZS 1170.0 or AS/NZS 1170.2 as applicable
3. Connections to be independently checked
4. Ultimate limit state to be checked separately
5. Lining contribution not included
6. Cantilever not to exceed 0.2 times the backspan

TABLE 17: PART NO. H550: 20 x 50 x 50 x 50 x 20mm

SPAN	H550 TOP HAT SPACING							
	L / 250				L / 360			
	SINGLE SPAN		CONTINUOUS SPAN		SINGLE SPAN		CONTINUOUS SPAN	
	450	600	450	600	450	600	450	600
900	14.31	10.73	27.03	20.27	9.93	7.45	18.76	14.07
1000	10.43	7.82	19.70	14.77	7.24	5.42	13.67	10.25
1100	7.83	5.87	14.79	11.09	5.43	4.07	10.27	7.70
1200	6.03	4.52	11.39	8.54	4.18	3.13	7.90	5.92
1300	4.74	3.55	8.95	6.71	3.28	2.46	6.21	4.65
1400	3.79	2.84	7.17	5.37	2.62	1.96	4.97	3.72
1500	3.08	2.30	5.82	4.36	2.13	1.59	4.04	3.02
1600	2.53	1.89	4.79	3.59	1.75	1.31	3.32	2.49
1700	2.11	1.58	3.99	2.99	1.46	1.09	2.77	2.07
1800	1.77	1.32	3.36	2.52	1.22	0.91	2.33	1.74

TABLE 18: PART NO. H560: 20 x 60 x 50 x 60 x 20mm

SPAN	H560 TOP HAT SPACING							
	L / 250				L / 360			
	SINGLE SPAN		CONTINUOUS SPAN		SINGLE SPAN		CONTINUOUS SPAN	
	450	600	450	600	450	600	450	600
900	16.82	12.61	19.00	14.25	15.68	11.76	19.00	14.25
1000	12.93	9.70	15.40	11.55	11.42	8.56	15.40	11.55
1100	10.07	7.55	12.73	9.55	8.57	6.43	12.73	9.55
1200	7.91	5.93	10.70	8.03	6.59	4.94	10.70	8.03
1300	6.23	4.67	9.12	6.84	5.17	3.88	9.12	6.84
1400	4.92	3.69	7.87	5.90	4.13	3.10	7.87	5.90
1500	3.88	2.91	6.72	5.04	3.35	2.51	6.46	4.85
1600	3.06	2.30	5.75	4.31	2.75	2.06	5.31	3.98
1700	2.46	1.84	4.94	3.71	2.29	1.72	4.42	3.32
1800	2.00	1.50	4.27	3.20	1.92	1.44	3.72	2.79

NOTES:

1. NA means the maximum kPa value is less than 0.25 kPa and the Top Hat configuration is not appropriate
2. Serviceability limit state load capacity to be calculated in accordance with AS/NZS 1170.0 or AS/NZS 1170.2 as applicable
3. Connections to be independently checked
4. Ultimate limit state to be checked separately
5. Lining contribution not included
6. Cantilever not to exceed 0.2 times the backspan

TOP HATS

Serviceability Limit State Load Tables (kPa)

1.15bmt (H) Top Hats (continued)

TABLE 19: PART NO. H715: 15 x 15 x 75 x 15 x 15mm

SPAN	H715 TOP HAT SPACING							
	L / 250				L / 360			
	SINGLE SPAN		CONTINUOUS SPAN		SINGLE SPAN		CONTINUOUS SPAN	
	450	600	450	600	450	600	450	600
900	0.95	0.71	1.81	1.35	0.65	0.48	1.25	0.93
1000	0.69	0.51	1.31	0.98	0.47	0.35	0.91	0.67
1100	0.51	0.38	0.98	0.73	0.35	0.26	0.68	0.50
1200	0.39	0.29	0.75	0.56	0.26	NA	0.52	0.38
1300	0.30	NA	0.59	0.43	NA	NA	0.40	0.30
1400	NA	NA	0.47	0.34	NA	NA	0.32	NA
1500	NA	NA	0.37	0.28	NA	NA	0.25	NA
1600	NA	NA	0.31	NA	NA	NA	NA	NA
1700	NA	NA	0.25	NA	NA	NA	NA	NA
1800	NA	NA	NA	NA	NA	NA	NA	NA

TABLE 20: PART NO. H725: 20 x 25 x 75 x 25 x 20mm

SPAN	H725 TOP HAT SPACING							
	L / 250				L / 360			
	SINGLE SPAN		CONTINUOUS SPAN		SINGLE SPAN		CONTINUOUS SPAN	
	450	600	450	600	450	600	450	600
900	3.37	2.53	6.38	4.78	2.34	1.75	4.43	3.32
1000	2.45	1.84	4.65	3.48	1.70	1.27	3.22	2.41
1100	1.84	1.37	3.49	2.61	1.27	0.95	2.42	1.81
1200	1.41	1.05	2.68	2.01	0.97	0.73	1.86	1.39
1300	1.11	0.82	2.10	1.57	0.76	0.57	1.46	1.09
1400	0.88	0.66	1.68	1.26	0.61	0.45	1.16	0.87
1500	0.71	0.53	1.36	1.02	0.49	0.36	0.94	0.70
1600	0.58	0.43	1.12	0.83	0.40	0.29	0.77	0.57
1700	0.48	0.36	0.93	0.69	0.33	NA	0.64	0.47
1800	0.40	0.30	0.78	0.58	0.27	NA	0.54	0.40

NOTES:

1. NA means the maximum kPa value is less than 0.25 kPa and the top hat configuration is not appropriate
2. Serviceability limit state load capacity to be calculated in accordance with AS/NZS 1170.0 or AS/NZS 1170.2 as applicable
3. Connections to be independently checked
4. Ultimate limit state to be checked separately
5. Lining contribution not included
6. Cantilever not to exceed 0.2 times the backspan

TABLE 21: PART NO. H735: 20 x 35 x 75 x 35 x 20mm

SPAN	H735 TOP HAT SPACING							
	L / 250				L / 360			
	SINGLE SPAN		CONTINUOUS SPAN		SINGLE SPAN		CONTINUOUS SPAN	
	450	600	450	600	450	600	450	600
900	7.30	5.47	13.80	10.35	5.07	3.80	9.58	7.18
1000	5.32	3.98	10.06	7.54	3.69	2.76	6.98	5.23
1100	3.99	2.99	7.55	5.66	2.77	2.07	5.24	3.92
1200	3.07	2.30	5.81	4.35	2.13	1.59	4.03	3.02
1300	2.41	1.80	4.57	3.42	1.67	1.25	3.17	2.37
1400	1.93	1.44	3.65	2.73	1.33	0.99	2.53	1.89
1500	1.56	1.17	2.97	2.22	1.08	0.80	2.05	1.54
1600	1.28	0.96	2.44	1.83	0.89	0.66	1.69	1.26
1700	1.07	0.80	2.03	1.52	0.73	0.55	1.40	1.05
1800	0.90	0.67	1.71	1.28	0.62	0.46	1.18	0.88

TABLE 22: PART NO. H750: 20 x 50 x 75 x 50 x 20mm

SPAN	H750 TOP HAT SPACING							
	L / 250				L / 360			
	SINGLE SPAN		CONTINUOUS SPAN		SINGLE SPAN		CONTINUOUS SPAN	
	450	600	450	600	450	600	450	600
900	17.06	12.79	32.21	24.15	11.84	8.87	22.36	16.76
1000	12.43	9.32	23.47	17.60	8.63	6.46	16.29	12.22
1100	9.33	6.99	17.63	13.22	6.48	4.85	12.24	9.17
1200	7.18	5.38	13.58	10.18	4.98	3.73	9.42	7.06
1300	5.65	4.23	10.67	8.00	3.92	2.93	7.41	5.55
1400	4.52	3.38	8.54	6.40	3.13	2.34	5.93	4.44
1500	3.67	2.75	6.94	5.20	2.54	1.90	4.81	3.61
1600	3.02	2.26	5.72	4.28	2.09	1.56	3.96	2.97
1700	2.51	1.88	4.76	3.57	1.74	1.30	3.30	2.47
1800	2.11	1.58	4.01	3.00	1.46	1.09	2.78	2.08

NOTES:

1. NA means the maximum kPa value is less than 0.25 kPa and the Top Hat configuration is not appropriate
2. Serviceability limit state load capacity to be calculated in accordance with AS/NZS 1170.0 or AS/NZS 1170.2 as applicable
3. Connections to be independently checked
4. Ultimate limit state to be checked separately
5. Lining contribution not included
6. Cantilever not to exceed 0.2 times the backspan

TOP HATS

Ultimate Limit State Load Tables (kPa)

0.75bmt (M) Top Hats

TABLE 23: PART NO. M515: 15 x 15 x 50 x 15 x 15mm

SPAN	M515 TOP HAT SPACING			
	SINGLE SPAN		CONTINUOUS SPAN	
	450	600	450	600
900	1.07	0.80	1.45	1.08
1000	0.80	0.60	1.15	0.86
1100	0.61	0.45	0.93	0.69
1200	0.47	0.35	0.76	0.57
1300	0.38	0.28	0.63	0.47
1400	0.30	0.22	0.53	0.39
1500	0.25	0.18	0.45	0.33
1600	0.21	0.15	0.39	0.29
1700	0.18	0.13	0.34	0.25
1800	0.15	0.11	0.30	0.22

TABLE 24: PART NO. M525: 20 x 25 x 50 x 25 x 20mm

SPAN	M525 TOP HAT SPACING			
	SINGLE SPAN		CONTINUOUS SPAN	
	450	600	450	600
900	2.31	1.73	3.12	2.34
1000	1.70	1.27	2.53	1.89
1100	1.25	0.93	2.09	1.56
1200	0.95	0.71	1.73	1.29
1300	0.74	0.55	1.42	1.06
1400	0.59	0.44	1.18	0.88
1500	0.47	0.35	0.98	0.73
1600	0.38	0.28	0.83	0.62
1700	0.31	0.23	0.70	0.52
1800	0.26	0.19	0.60	0.45

NOTES:

1. NA means the maximum kPa value is less than 0.25 kPa and the top hat configuration is not appropriate
2. Ultimate Limit state load capacity to be calculated in accordance with AS/NZS 1170.0 or AS/NZS 1170.2 as applicable
3. Connections to be independently checked
4. Serviceability limit state to be checked separately
5. Lining contribution not included
6. Cantilever not to exceed 0.2 times the backspan

TABLE 25: PART NO. M535: 20 x 35 x 50 x 35 x 20mm

SPAN	M535 TOP HAT SPACING			
	SINGLE SPAN		CONTINUOUS SPAN	
	450	600	450	600
900	3.85	2.88	4.94	3.70
1000	2.85	2.13	4.00	3.00
1100	2.12	1.59	3.22	2.41
1200	1.57	1.17	2.60	1.95
1300	1.20	0.90	2.12	1.59
1400	0.92	0.69	1.75	1.31
1500	0.72	0.54	1.45	1.08
1600	0.57	0.42	1.21	0.90
1700	0.47	0.35	1.01	0.75
1800	0.38	0.28	0.85	0.63

TABLE 26: PART NO. M545: 20 x 45 x 50 x 45 x 20mm

SPAN	M545 TOP HAT SPACING			
	SINGLE SPAN		CONTINUOUS SPAN	
	450	600	450	600
900	6.07	4.55	7.15	5.36
1000	4.61	3.45	5.79	4.34
1100	3.53	2.64	4.79	3.59
1200	2.71	2.03	4.03	3.02
1300	2.08	1.56	3.42	2.56
1400	1.60	1.20	2.91	2.18
1500	1.26	0.94	2.49	1.87
1600	1.00	0.75	2.16	1.62
1700	0.81	0.61	1.88	1.41
1800	0.66	0.50	1.63	1.22

NOTES:

1. NA means the maximum kPa value is less than 0.25 kPa and the Top Hat configuration is not appropriate
2. Ultimate Limit state load capacity to be calculated in accordance with AS/NZS 1170.0 or AS/NZS 1170.2 as applicable
3. Connections to be independently checked
4. Serviceability limit state to be checked separately
5. Lining contribution not included
6. Cantilever not to exceed 0.2 times the backspan

TOP HATS

Ultimate Limit State Load Tables:

0.75bmt (M) Top Hats (continued)

TABLE 27: PART NO. M550: 20 x 50 x 50 x 50 x 20mm

SPAN	M550 TOP HAT SPACING			
	SINGLE SPAN		CONTINUOUS SPAN	
	450	600	450	600
900	6.65	4.98	8.30	6.22
1000	4.94	3.70	6.72	5.04
1100	3.68	2.76	5.37	4.02
1200	2.72	2.04	4.32	3.24
1300	2.04	1.53	3.52	2.64
1400	1.57	1.17	2.88	2.16
1500	1.21	0.90	2.37	1.77
1600	0.95	0.71	1.96	1.47
1700	0.76	0.57	1.62	1.21
1800	0.62	0.46	1.33	0.99

TABLE 28: PART NO. M560: 20 x 60 x 50 x 60 x 20mm

SPAN	M560 TOP HAT SPACING			
	SINGLE SPAN		CONTINUOUS SPAN	
	450	600	450	600
900	9.60	7.20	10.98	8.24
1000	7.33	5.50	8.90	6.67
1100	5.66	4.24	7.36	5.52
1200	4.38	3.29	6.19	4.64
1300	3.39	2.54	5.27	3.95
1400	2.62	1.96	4.53	3.40
1500	2.04	1.53	3.90	2.92
1600	1.61	1.21	3.37	2.53
1700	1.30	0.97	2.94	2.21
1800	1.05	0.79	2.54	1.90

NOTES:

1. NA means the maximum kPa value is less than 0.25 kPa and the top hat configuration is not appropriate
2. Ultimate Limit state load capacity to be calculated in accordance with ASINZS 1170.0 or ASINZS 1170.2 as applicable
3. Connections to be independently checked
4. Serviceability limit state to be checked separately
5. Lining contribution not included
6. Cantilever not to exceed 0.2 times the backspan

TABLE 29: PART NO. M715: 15 x 15 x 75 x 15 x 15mm

SPAN	M715 TOP HAT SPACING			
	SINGLE SPAN		CONTINUOUS SPAN	
	450	600	450	600
900	1.33	0.99	1.57	1.17
1000	1.02	0.76	1.27	0.95
1100	0.79	0.59	1.04	0.78
1200	0.63	0.47	0.86	0.64
1300	0.5	0.37	0.72	0.54
1400	0.40	0.30	0.61	0.45
1500	0.32	0.24	0.52	0.39
1600	0.26	0.19	0.45	0.33
1700	0.22	0.16	0.39	0.29
1800	0.18	0.13	0.34	0.25

TABLE 30: PART NO. M725: 20 x 25 x 75 x 25 x 20mm

SPAN	M725 TOP HAT SPACING			
	SINGLE SPAN		CONTINUOUS SPAN	
	450	600	450	600
900	2.97	2.22	3.29	2.46
1000	2.31	1.73	2.66	1.99
1100	1.81	1.35	2.2	1.65
1200	1.44	1.08	1.85	1.38
1300	1.15	0.86	1.58	1.18
1400	0.92	0.69	1.36	1.02
1500	0.75	0.56	1.18	0.88
1600	0.6	0.45	1.03	0.77
1700	0.5	0.37	0.90	0.67
1800	0.41	0.3	0.79	0.59

NOTES:

1. NA means the maximum kPa value is less than 0.25 kPa and the Top Hat configuration is not appropriate
2. Ultimate Limit state load capacity to be calculated in accordance with AS/NZS 1170.0 or AS/NZS 1170.2 as applicable
3. Connections to be independently checked
4. Serviceability limit state to be checked separately
5. Lining contribution not included
6. Cantilever not to exceed 0.2 times the backspan

TOP HATS

Ultimate Limit State Load Tables:

0.75bmt (M) Top Hats (continued)

TABLE 31: PART NO. M735: 20 x 35 x 75 x 35 x 20mm

SPAN	M735 TOP HAT SPACING			
	SINGLE SPAN		CONTINUOUS SPAN	
	450	600	450	600
900	4.97	3.72	5.26	3.94
1000	3.88	2.91	4.26	3.19
1100	3.08	2.31	3.52	2.64
1200	2.47	1.85	2.96	2.22
1300	2.00	1.50	2.52	1.89
1400	1.63	1.22	2.17	1.62
1500	1.33	0.99	1.89	1.41
1600	1.09	0.81	1.67	1.25
1700	0.89	0.66	1.45	1.08
1800	0.73	0.54	1.26	0.94

TABLE 32: PART NO. M750: 20 x 50 x 75 x 50 x 20mm

SPAN	M750 TOP HAT SPACING			
	SINGLE SPAN		CONTINUOUS SPAN	
	450	600	450	600
900	8.54	6.4	8.88	6.66
1000	6.7	5.02	7.19	5.39
1100	5.34	4.00	5.94	4.45
1200	4.31	3.23	4.99	3.74
1300	3.51	2.63	4.26	3.19
1400	2.87	2.15	3.67	2.75
1500	2.36	1.77	3.2	2.39
1600	1.94	1.45	2.77	2.07
1700	1.59	1.19	2.39	1.79
1800	1.30	0.97	2.08	1.56

NOTES:

1. NA means the maximum kPa value is less than 0.25 kPa and the top hat configuration is not appropriate
2. Ultimate Limit state load capacity to be calculated in accordance with ASINZS 1170.0 or ASINZS 1170.2 as applicable
3. Connections to be independently checked
4. Serviceability limit state to be checked separately
5. Lining contribution not included
6. Cantilever not to exceed 0.2 times the backspan

Ultimate Limit State Load Tables: 1.15bmt (H) Top Hats

TABLE 33: PART NO. H515: 15 x 15 x 50 x 15 x 15mm

SPAN	H515 TOP HAT SPACING			
	SINGLE SPAN		CONTINUOUS SPAN	
	450	600	450	600
900	1.93	1.44	2.32	1.74
1000	1.52	1.14	1.85	1.38
1100	1.22	0.91	1.51	1.13
1200	1.00	0.75	1.26	0.94
1300	0.84	0.63	1.06	0.79
1400	0.71	0.53	0.90	0.67
1500	0.60	0.45	0.78	0.58
1600	0.52	0.39	0.68	0.51
1700	0.45	0.33	0.60	0.45
1800	0.40	0.29	0.53	0.39

TABLE 34: PART NO. H525: 20 x 25 x 50 x 25 x 20mm

SPAN	H525 TOP HAT SPACING			
	SINGLE SPAN		CONTINUOUS SPAN	
	450	600	450	600
900	4.45	3.33	5.61	4.2
1000	3.39	2.54	4.54	3.4
1100	2.61	1.95	3.67	2.75
1200	2.05	1.53	3.01	2.25
1300	1.63	1.22	2.51	1.88
1400	1.31	0.98	2.11	1.58
1500	1.08	0.81	1.80	1.35
1600	0.90	0.67	1.55	1.16
1700	0.76	0.57	1.34	1.00
1800	0.65	0.48	1.18	0.88

NOTES:

1. NA means the maximum kPa value is less than 0.25 kPa and the Top Hat configuration is not appropriate
2. Ultimate Limit state load capacity to be calculated in accordance with AS/NZS 1170.0 or AS/NZS 1170.2 as applicable
3. Connections to be independently checked
4. Serviceability limit state to be checked separately
5. Lining contribution not included
6. Cantilever not to exceed 0.2 times the backspan

TOP HATS

Ultimate Limit State Load Tables:

1.15bmt (H) Top Hats (continued)

TABLE 35: PART NO. H535: 20 x 35 x 50 x 35 x 20mm

SPAN	H535 TOP HAT SPACING			
	SINGLE SPAN		CONTINUOUS SPAN	
	450	600	450	600
900	7.03	5.27	8.79	6.59
1000	5.26	3.94	6.97	5.22
1100	3.98	2.98	5.59	4.19
1200	3.03	2.27	4.56	3.42
1300	2.33	1.74	3.76	2.82
1400	1.83	1.37	3.14	2.35
1500	1.47	1.10	2.65	1.98
1600	1.20	0.90	2.25	1.68
1700	1.00	0.75	1.93	1.44
1800	0.84	0.63	1.67	1.25

TABLE 36: PART NO. H545: 20 x 45 x 50 x 45 x 20mm

SPAN	H545 TOP HAT SPACING			
	SINGLE SPAN		CONTINUOUS SPAN	
	450	600	450	600
900	10.96	8.22	12.61	9.45
1000	8.42	6.31	10.22	7.66
1100	6.56	4.92	8.45	6.33
1200	5.16	3.87	7.10	5.33
1300	4.08	3.06	6.06	4.54
1400	3.25	2.43	5.16	3.87
1500	2.58	1.94	4.44	3.33
1600	2.07	1.55	3.82	2.86
1700	1.68	1.26	3.29	2.47
1800	1.38	1.03	2.85	2.14

NOTES:

1. NA means the maximum kPa value is less than 0.25 kPa and the top hat configuration is not appropriate
2. Ultimate Limit state load capacity to be calculated in accordance with AS/NZS 1170.0 or AS/NZS 1170.2 as applicable
3. Connections to be independently checked
4. Serviceability limit state to be checked separately
5. Lining contribution not included
6. Cantilever not to exceed 0.2 times the backspan

TABLE 37: PART NO. H550: 20 x 50 x 50 x 50 x 20mm

SPAN	H550 TOP HAT SPACING			
	SINGLE SPAN		CONTINUOUS SPAN	
	450	600	450	600
900	11.72	8.79	14.47	10.85
1000	8.78	6.58	11.43	8.57
1100	6.55	4.91	9.13	6.84
1200	4.89	3.66	7.39	5.54
1300	3.67	2.75	6.05	4.53
1400	2.82	2.11	4.99	3.74
1500	2.21	1.65	4.16	3.12
1600	1.77	1.32	3.48	2.61
1700	1.44	1.08	2.93	2.19
1800	1.19	0.89	2.48	1.86

TABLE 38: PART NO. H560: 20 x 60 x 50 x 60 x 20mm

SPAN	H560 TOP HAT SPACING			
	SINGLE SPAN		CONTINUOUS SPAN	
	450	600	450	600
900	16.82	12.61	19.00	14.25
1000	12.93	9.70	15.40	11.55
1100	10.07	7.55	12.73	9.55
1200	7.91	5.93	10.70	8.03
1300	6.23	4.67	9.12	6.84
1400	4.92	3.69	7.87	5.90
1500	3.88	2.91	6.72	5.04
1600	3.06	2.30	5.75	4.31
1700	2.46	1.84	4.94	3.71
1800	2.00	1.50	4.27	3.20

NOTES:

1. NA means the maximum kPa value is less than 0.25 kPa and the Top Hat configuration is not appropriate
2. Ultimate Limit state load capacity to be calculated in accordance with AS/NZS 1170.0 or AS/NZS 1170.2 as applicable
3. Connections to be independently checked
4. Serviceability limit state to be checked separately
5. Lining contribution not included
6. Cantilever not to exceed 0.2 times the backspan

TOP HATS

Ultimate Limit State Load Tables:

1.15bmt (H) Top Hats (continued)

TABLE 39: PART NO. H715: 15 x 15 x 75 x 15 x 15mm

SPAN	H715 TOP HAT SPACING			
	SINGLE SPAN		CONTINUOUS SPAN	
	450	600	450	600
900	2.18	1.63	2.45	1.83
1000	1.71	1.28	1.98	1.48
1100	1.37	1.02	1.64	1.23
1200	1.11	0.83	1.37	1.02
1300	0.92	0.69	1.16	0.87
1400	0.77	0.57	0.98	0.73
1500	0.65	0.48	0.85	0.63
1600	0.56	0.42	0.74	0.55
1700	0.49	0.36	0.65	0.48
1800	0.42	0.31	0.57	0.42

TABLE 40: PART NO. H725: 20 x 25 x 75 x 25 x 20mm

SPAN	H725 TOP HAT SPACING			
	SINGLE SPAN		CONTINUOUS SPAN	
	450	600	450	600
900	5.45	4.08	5.86	4.39
1000	4.18	3.13	4.75	3.56
1100	3.32	2.49	3.92	2.94
1200	2.68	2.01	3.30	2.47
1300	2.19	1.64	2.81	2.10
1400	1.80	1.35	2.40	1.80
1500	1.49	1.11	2.06	1.54
1600	1.24	0.93	1.78	1.33
1700	1.04	0.78	1.56	1.17
1800	0.88	0.66	1.37	1.02

NOTES:

1. NA means the maximum kPa value is less than 0.25 kPa and the top hat configuration is not appropriate
2. Ultimate Limit state load capacity to be calculated in accordance with ASINZS 1170.0 or ASINZS 1170.2 as applicable
3. Connections to be independently checked
4. Serviceability limit state to be checked separately
5. Lining contribution not included
6. Cantilever not to exceed 0.2 times the backspan

TABLE 41: PART NO. H735: 20 x 35 x 75 x 35 x 20mm

SPAN	H735 TOP HAT SPACING			
	SINGLE SPAN		CONTINUOUS SPAN	
	450	600	450	600
900	8.74	6.55	9.28	6.96
1000	6.85	5.13	7.51	5.63
1100	5.46	4.09	6.21	4.65
1200	4.40	3.30	5.22	3.91
1300	3.59	2.69	4.45	3.33
1400	2.96	2.22	3.78	2.83
1500	2.44	1.83	3.24	2.43
1600	2.01	1.50	2.79	2.09
1700	1.67	1.25	2.43	1.82
1800	1.39	1.04	2.13	1.59

TABLE 42: PART NO. H750: 20 x 50 x 75 x 50 x 20mm

SPAN	H750 TOP HAT SPACING			
	SINGLE SPAN		CONTINUOUS SPAN	
	450	600	450	600
900	14.72	11.04	15.31	11.48
1000	11.55	8.66	12.40	9.30
1100	9.22	6.91	10.25	7.68
1200	7.45	5.58	8.61	6.45
1300	6.08	4.56	7.27	5.45
1400	5.00	3.75	6.16	4.62
1500	4.13	3.09	5.26	3.94
1600	3.40	2.55	4.53	3.39
1700	2.80	2.10	3.93	2.94
1800	2.30	1.72	3.43	2.57

NOTES:

1. NA means the maximum kPa value is less than 0.25 kPa and the Top Hat configuration is not appropriate
2. Ultimate Limit state load capacity to be calculated in accordance with AS/NZS 1170.0 or AS/NZS 1170.2 as applicable
3. Connections to be independently checked
4. Serviceability limit state to be checked separately
5. Lining contribution not included
6. Cantilever not to exceed 0.2 times the backspan

REVEAL BEADS

Rondo Reveal Beads are available in a variety of widths and offer a strong, straight and clean finish to window openings that require internal trimming. They are cold rolled from 0.9mm Zincoanneal steel and UV-resistant to make them strong and able to withstand harsh UV rays without cracking or breaking down.

Rondo Reveal Beads can be cut by hand with sharp shears, or with other cutting devices, such as a drop saw and installed as shown in Figure 9.

It incorporates a perforated bead leg for setting into the surrounding wall lining and can be painted over to match the wall finish.

Rondo recommends each application to be bedded in with a suitable gap-filling adhesive to the supporting framework around the window opening, whether it is masonry, timber or steel studding. A bead of paintable gap-filler can be applied to finish butt corner intersections.

In the event that a Reveal Bead requires trimming down, the cut edge can be easily finished with Rondo EXTREME® Finish Trim PLBFT30 as shown in Figure 10.



■ REVEAL BEAD INSTALLATION



■ REVEAL BEAD WITH FINISHING TRIM

ANGLES

Rondo has a range of Steel Angles available, including heavy duty and slotted angles.

Rondo Heavy Duty Angles are manufactured from Bluescope Steel G2 Z275 material to suit both lightweight Auto-claved Aerated Concrete Panel Systems (AAC) and steel framing requirements for façade systems.

The Heavy Duty Angles are 75 x 75mm and 100 x 100mm nominal sized and are available in 0.75 and 1.15bmt steel thicknesses, and can be used to strengthen internal corners of façade systems, in the construction of bulkhead framing or in a variety of situations requiring bracing or stiffening.

The slotted angles can be used for head and base fixing for AAC panel systems.

NOTE:

Due to their weight and subsequent OH&S handling requirements, Rondo only supplies the slotted and Heavy Duty Angles in lengths no longer than 2400mm.

11

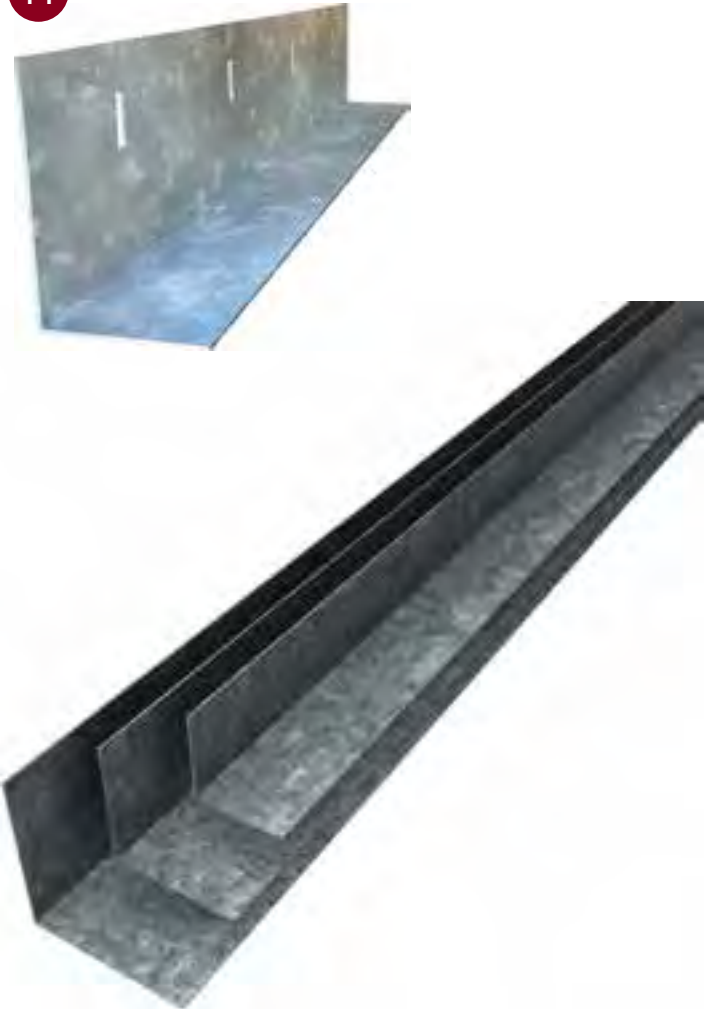

■ RONDO STEEL ANGLES

SPEEDPANEL

Rondo produces two accessories for specific use with the 78mm Speedpanel systems. Both are manufactured from G2 Z275 Blue Scope Galvabond Steel. Rondo 820 'C' Channel is 82 x 51mm nominally sized and available in 1.15bmt steel thickness and Rondo 559 90° Angle is 50 x 50mm nominally sized and available in a 1.15bmt steel thickness.

These products are made to suit the 78mm Speedpanel system specifically but Rondo is able to produce Speedpanel 'C' channels and angles to suit other sizes of speedpanel by special request.

NOTE: Please refer to the Speedpanel system literature for correct installation procedures.

RONDO ROD BENDER

The Rondo 130 Rod Bender can bend three rods to 30° at a time, and has been designed to accommodate Rondo 121 Plain Rod and 122 Threaded One End Rod – providing both onsite time and labour cost savings.

To use, first ensure tool is secure, then unscrew handle from mounting block and screw into pivot.

Rotate the handle through 180° and insert rods up to stopping block. Finally, pull the handle back in opposite direction to bend rod.

NOTE: Rondo recommends a 30° bend is applied to Rondo 121 and 122 Rod in Rondo Suspended Ceiling Systems to ensure optimum performance.



■ ROD BENDER